

SHARP

AR-6023DV

Digital Multifunction System

**Double Your Document Power
with a Duplex-Capable MFD**



Upgrade to Smooth and Easy Document Productivity

Whether you're printing, copying, or scanning, the AR-6023DV makes document management easy for everyone in the office. Core document functions are complemented by a range of useful advanced functions. And if the needs of your growing enterprise evolve, rest assured the AR-6023DV is ready to grow with you. Optional hardware and software upgrades let you add useful extra functions to your office setup. It all comes together in one compact, productivity-boosting package.

DOCUMENT WORKFLOW

Convenient Full-Colour Scanning

The AR-6023DV works as a full-colour A3 scanner. In addition to scanning via a TWAIN driver, the MFD has a Button Manager function. As well as letting you adjust settings such as scan resolution, this function allows you to assign applications such as e-mail, Microsoft® Word, OCR, and Sharpdesk to six Scan Menu buttons on the MFD's control panel. Scanning, data transfer, and application start-up can all be done automatically. Operation is quick and easy—simply tap the Scan Mode button, select a pre-registered Scan Menu button, and press Start.

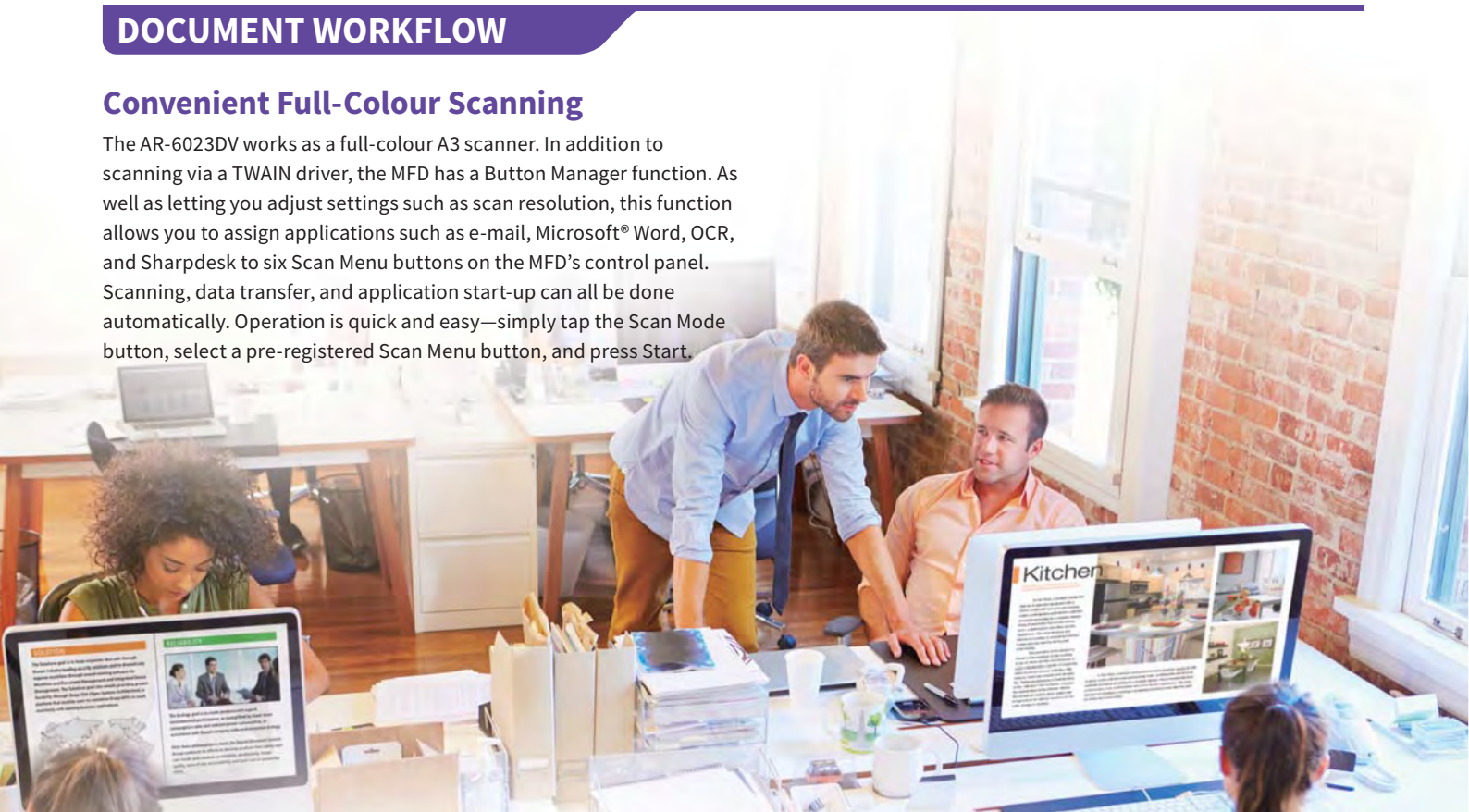

Example of Assigning Buttons When Upgraded to Full-Colour Network Scanning

Adding the optional AR-NB7 N Network Expansion Kit upgrades the AR-6023DV to a full-colour network scanner, enhancing its scan functionality.

Button 1-3 Scan to E-mail*¹ A/B/C

Scanned files can be sent as an attachment to any e-mail address over the Internet.

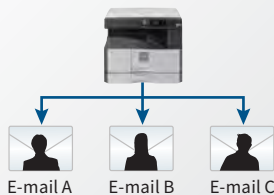

Button 6 Scan to Desktop*² or Mobile Device*^{1*3}

Scanned files can be forwarded directly to your PC or a mobile device.

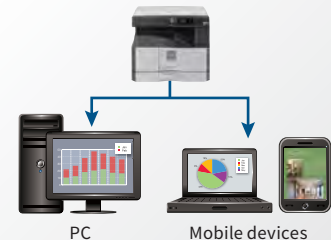

Button 4 Scan to FTP Server*¹

Scanned files can be stored on a file server where they can be easily accessed from any PC on the network.

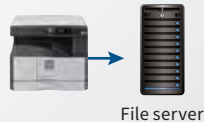

Button 5 Scan to USB Drive*¹

Scanned files can be stored directly on a USB drive.



Note: Buttons 1-6 must be assigned a scan destination in advance. Scan to Desktop and Scan to Mobile Device can be assigned to Button 6 only. Choose which one you would like to assign.

*1: Requires optional AR-NB7 N. *2: Requires optional Sharpdesk License Kit. Sharpdesk must be installed on PC. *3: Mobile device must have Sharpdesk Mobile app installed.

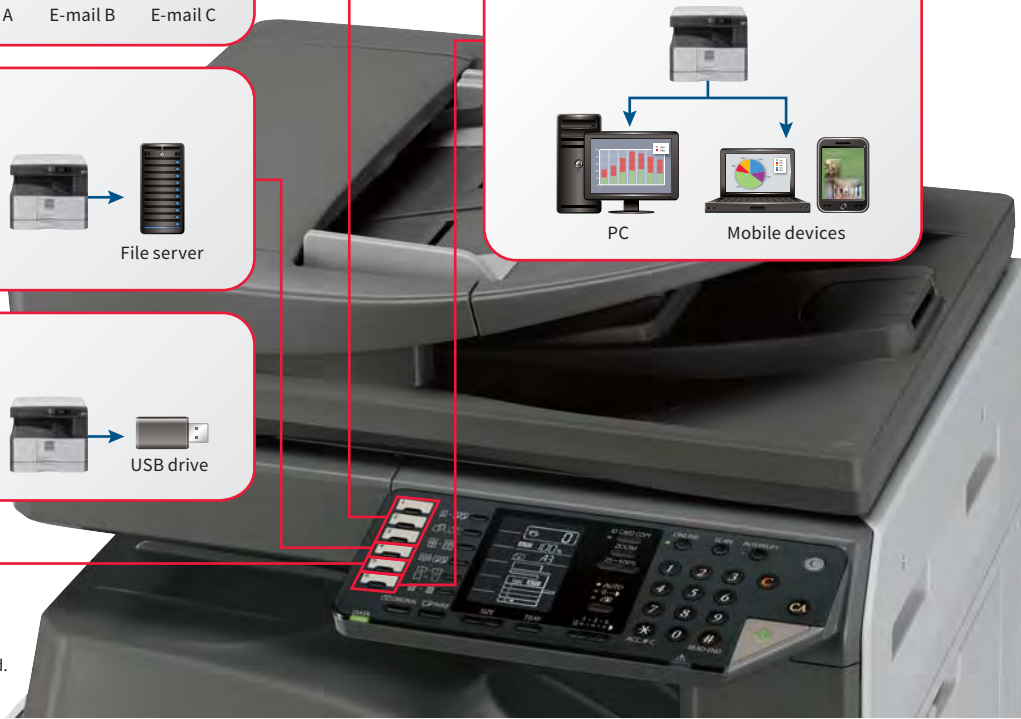

3-in-1 PERFORMANCE

Super-Efficient Output

The AR-6023DV delivers a fast output of 23 ppm*. The first copy comes out in just 6.4 seconds for A4, saving valuable time when you're doing multiple short-run jobs.

*A4, long-edge feeding



Automatic Document Feeding

An optional RSPF (reversing single pass feeder) efficiently feeds in up to 100 sheets of either one- or two-sided originals.



Built-in Stackless Duplex Module

The AR-6023DV can make two-sided printouts using its built-in stackless duplex module. This effectively reduces paper costs and saves filing space. Duplex copying is even more effective when used together with the optional RSPF.



Effective Paper Handling

For large-volume jobs and a wider selection of available paper sizes, these MFDs can accommodate two types of extra trays that increase total paper capacity to 1,850 sheets. These MFDs can accommodate heavy paper up to 200 g/m²*, expanding the range of possible printing applications.

*106–200 g/m² paper to be fed through multi-bypass tray.

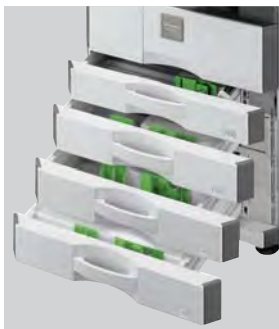

Printing with Sharp Technology

These MFDs incorporate Sharp's original SPLC (Sharp Printer Language with Compression) printing technology. SPLC effectively reduces the data size of a print job, speeding up data transfer and printing while improving overall throughput.

Network Printing

The optional AR-NB7 N Network Expansion Kit upgrades the MFD to a network printer that supports PCL 6 emulation. The further addition of the optional MX-PK10 PS Expansion Kit allows the MFD to support PostScript® 3™ emulation, giving you increased font compatibility and better graphics handling.

ID Card Copy

The AR-6023DV has a dedicated key for easy copying of both sides of a card (e.g., an ID or credit card) onto a single page.

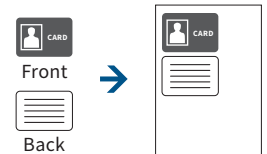

Rotation Sort*

Every other copy is rotated 90 degrees when delivered to the output tray. This takes the hassle out of sorting copies and comes in handy when you need to print multiple copies.

*Two paper trays must be loaded with the same-sized paper in a different orientation (landscape and portrait).



Other Convenient Features

- 2-in-1/4-in-1 copying
- Margin shift
- Edge/centre erase

OTHER KEY FEATURES

Sharpdesk Mobile*

Sharpdesk Mobile is a mobile print/scan application. With Sharpdesk Mobile, users can import documents scanned on the AR-6023DV/6020DV to their mobile devices for previewing and saving. And files on a mobile device can be printed out on the MFD, sent as e-mail attachments, or used in other applications.

*Requires commercially available wireless LAN router and optional AR-NB7 N; PDF printing additionally requires optional MX-PK10. Availability varies by country/region. For details, see the support website:

http://sharp-world.com/products/copier/docu_solutions/mobile/sharpdesk_mobile/



Sharpdesk*

With Sharpdesk integrated document management software, scanned files can be organised, edited, converted, and combined with ease. What's more, Full Text Search makes it easy to retrieve your documents.

*Requires optional Sharpdesk License Kit.

Energy Efficiency

Pressing the power save key after a job is finished immediately puts the MFD into auto power shut-off mode, further reducing your running costs.

SPECIFICATIONS

General

Type	Desktop
Engine speed	A4*1: Max. 23 ppm A3: Max. 12 ppm
Control panel display	Custom LCD
Paper size	Max. A3, min. A6*2
Paper capacity (80 g/m ²)	Standard: 350 sheets (250-sheet tray and 100-sheet multi-bypass tray) Maximum: 1,850 sheets (350 sheets & optional 500-sheet tray x 3)
Paper weight	Tray: 55 g/m ² to 105 g/m ² Multi-bypass tray: 55 g/m ² to 200 g/m ²
Warm-up time*3	25 sec.
Memory	Standard: 64 MB Maximum: 448 MB*4
Power requirements	Rated local AC voltage \pm 10%, 50/60 Hz
Power consumption	Max. 1.2 kW
Dimensions (W x D x H)*5	599 x 612 x 511 mm
Weight (approx.)*5	29 kg

Copier

Original paper size	Max. A3
First copy time*6	A4: 6.4 seconds
Continuous copy	Max. 999 copies
Resolution	600 x 600 dpi
Gradation	256 levels
Zoom range	25% to 400% (50% to 200% using RSPF) in 1% increments
Preset copy ratios*7	Metric: 10 ratios (5R/5E), inch: 10 ratios (5R/5E)

Printer

Resolution	600 x 600 dpi
Interface	USB 2.0
Supported OS	Windows Vista®, Windows® 7, Windows® 8.1, Windows® 10
PDL	SPLC (Sharp Printer Language with Compression)

*1: Long-edge feeding. *2: Short-edge feeding only. *3: At rated voltage, 23°C. May vary depending on operating conditions and environment. *4: 128 MB memory provided by optional MX-EB21 and 256 MB by optional AR-NB7 N. *5: Including document cover and adjuster. *6: Long-edge feeding from 1st paper tray. May vary depending on operating conditions and environment. *7: Preset copy ratios of 25% and 400% cannot be used with RSPF. *8: Resolution will vary depending on the size of the scanned area. *9: Colour/greyscale only. *10: Available only with Button Manager. *11: Requires optional Sharpdesk License Kit. *12: Mac OS requires optional MX-PK10. *13: PostScript 3 requires optional MX-PK10.

Colour Scanner

Scan method	Push scan (Button Manager) Pull scan (TWAIN-compliant application)
Resolution	Push scan: 75, 100, 150, 200, 300, 400, 600 dpi Pull scan: 75, 100, 150, 200, 300, 400, 600 dpi; 50 dpi to 9,600 dpi via user setting*8
File formats	TIFF, PDF, JPEG*9, BMP*10
Protocols	WIA, TWAIN
Scanner utilities	Button Manager, Sharpdesk*11
Scan destination	Scan to desktop*11

Network Printer (requires optional AR-NB7 N)

Resolution	600 x 600 dpi
Interface	USB 2.0, 10Base-T/100Base-TX
Supported OS*12	Windows Server® 2008, Windows Server® 2008 R2, Windows Server® 2012, Windows Server® 2012 R2, Windows Server® 2016, Windows Vista®, Windows® 7, Windows® 8.1, Windows® 10, Mac OS 10.6, 10.7, 10.8, 10.9, 10.10, 10.11, 10.12, 10.13
Network protocols	TCP/IP
PDL	PCL 6 emulation, PostScript® 3™ emulation*13
Available fonts	80 fonts for PCL, 136 fonts for PostScript 3 emulation

Network Scanner (requires optional AR-NB7 N)

Scan method	Push scan (via control panel) Pull scan (TWAIN-compliant application)
Resolution	Push scan: 75, 100, 150, 200, 300, 400, 600 dpi Pull scan: 75, 100, 150, 200, 300, 400, 600 dpi; 50 dpi to 9,600 dpi via user setting*8
File formats	TIFF, PDF, JPEG*9
Scanner utility	Sharpdesk*11
Scan destinations	Scan to e-mail/desktop*11/FTP server/USB drive

• Design and specifications are subject to change without prior notice.
• PCL is a registered trademark of Hewlett-Packard Company. PostScript 3 is either a registered trademark or trademark of Adobe Systems Incorporated in the US and/or other countries. Microsoft, Windows, Windows Server, and Windows Vista are registered trademarks of Microsoft Corporation in the US and/or other countries. Mac is a trademark of Apple Inc., registered in the US and other countries. All other brand names and product names may be trademarks or registered trademarks of their respective owners.

SYSTEM CONFIGURATION

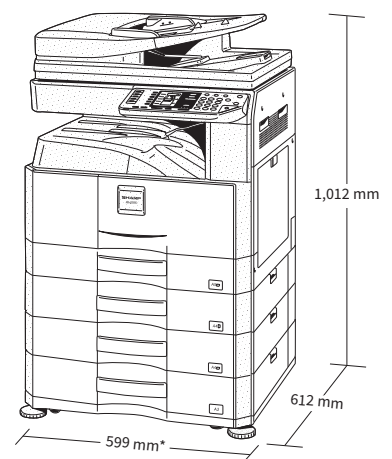
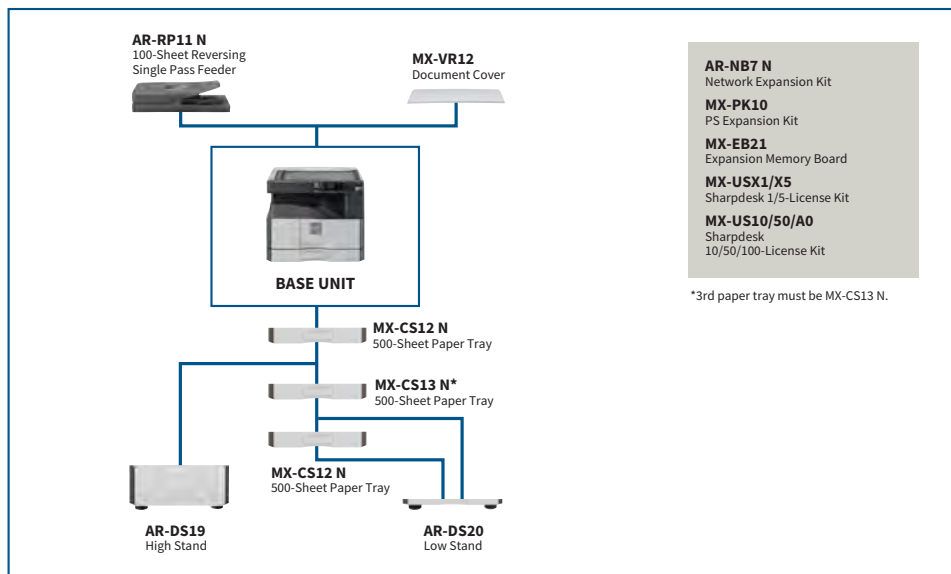

Shown with options.